

Precision Health Scale Model UC-322

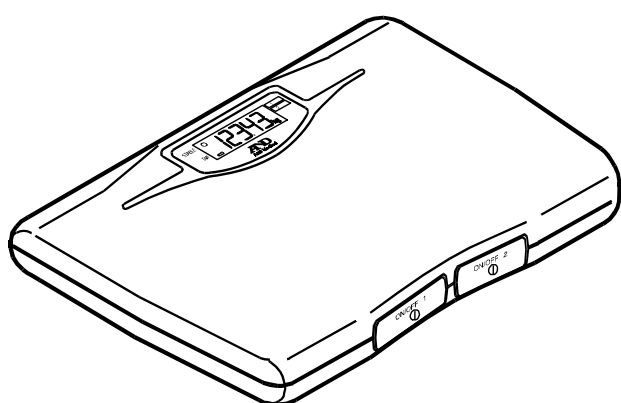

Before Use	
Precautions	1
Scale Components	2
Display Symbols	3
Installing (or Replacing) Batteries	4
Maintaining the Scale	4
Measuring Your Weight on a Carpet	5
Before Measuring Your Weight	5
Operations	
Resetting Your Height	6
Measuring Your Weight (With the preset height) ..	7
Measuring Your Weight (With no preset height) ..	8
Measuring Your Weight (Guest mode)	9
Displaying Data Saved in Memory	10
Deleting Data Saved in Memory	11
References	
Specifications	12
Before Requesting Service	12
How to Dispose of the Scale	12

Precautions

Please read this booklet before using your scale.

Your scale contains delicate, high-precision parts. Avoid extremes in temperature, humidity, direct sunlight, shock, moisture and dust.

Do not place your scale on a soft, wet or slippery floor. Place your scale on a solid and level floor.

Do not step on your scale with your feet wet so as to prevent you from slipping and falling down. Step on the center portion of your scale gently.

Do not step on the display window.

Do not disassemble or modify your scale.

Keep your scale free of dust and foreign materials.

Holding the switch for extended periods will shorten battery life.

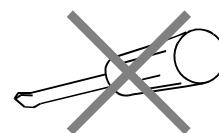
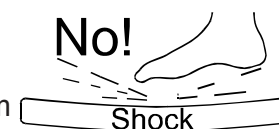

Indications for Use

The UC-322 was designed to be used indoors.

Compliance with European Directives

CE The scale complies with the statutory EMC (Electromagnetic Compatibility) directive 89/336/EEC and the Low Voltage Directive 73/23/EEC. **Note: The displayed value may be adversely affected under extreme electromagnetic influences.**

WM+PD4001090A

Scale Components

Top

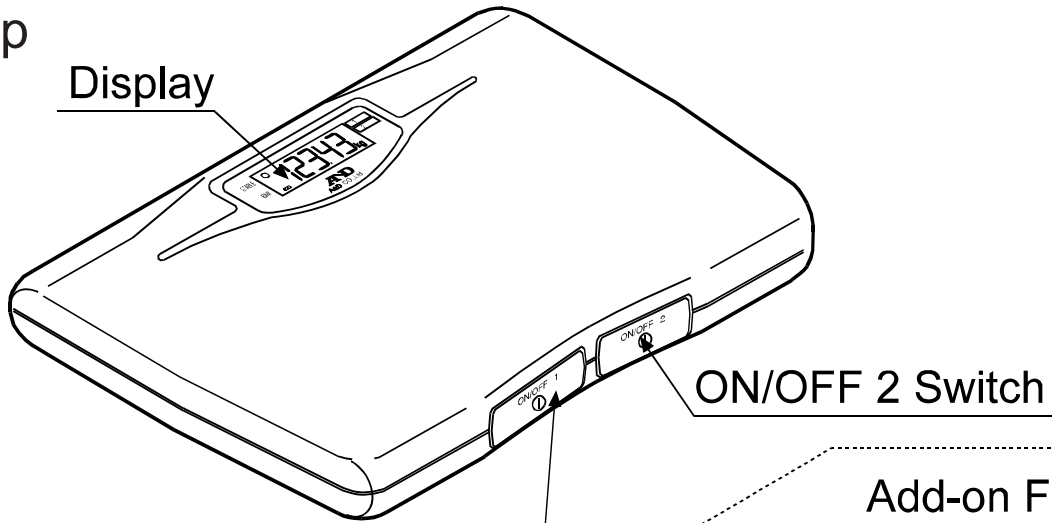

ON/OFF 1 Switch

ON/OFF 2 Switch

Add-on Foot

Underside

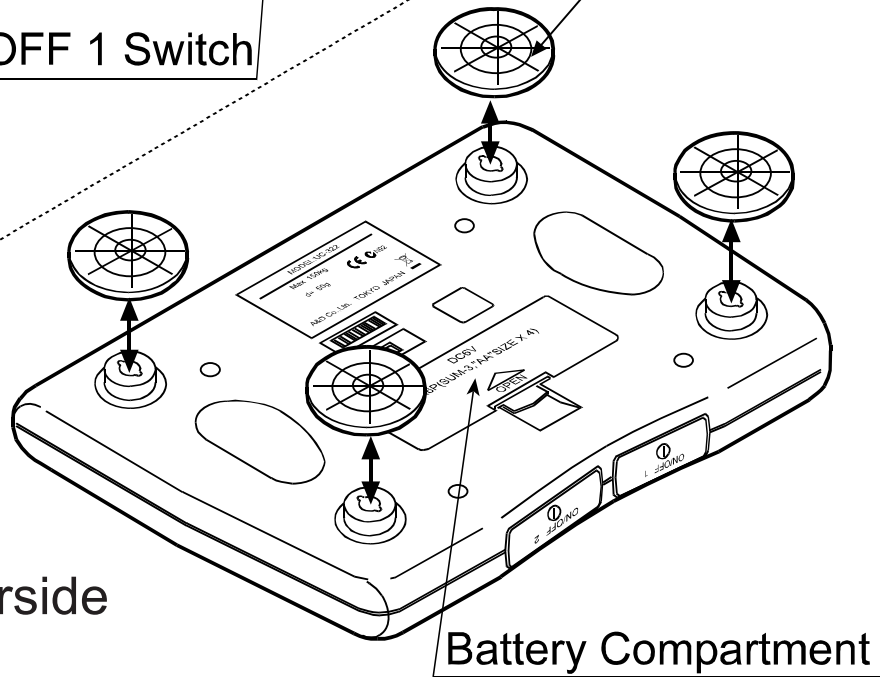

Battery Compartment

Standard Accessories

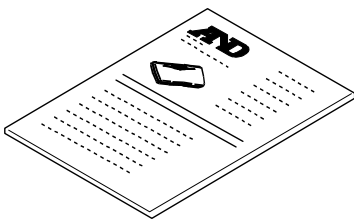

Instruction Manual

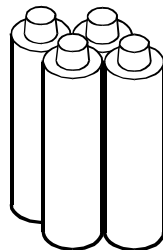

Batteries
(R6P or AA)

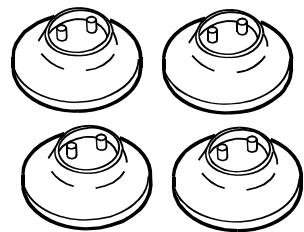

Add-on Feet

Display Symbols

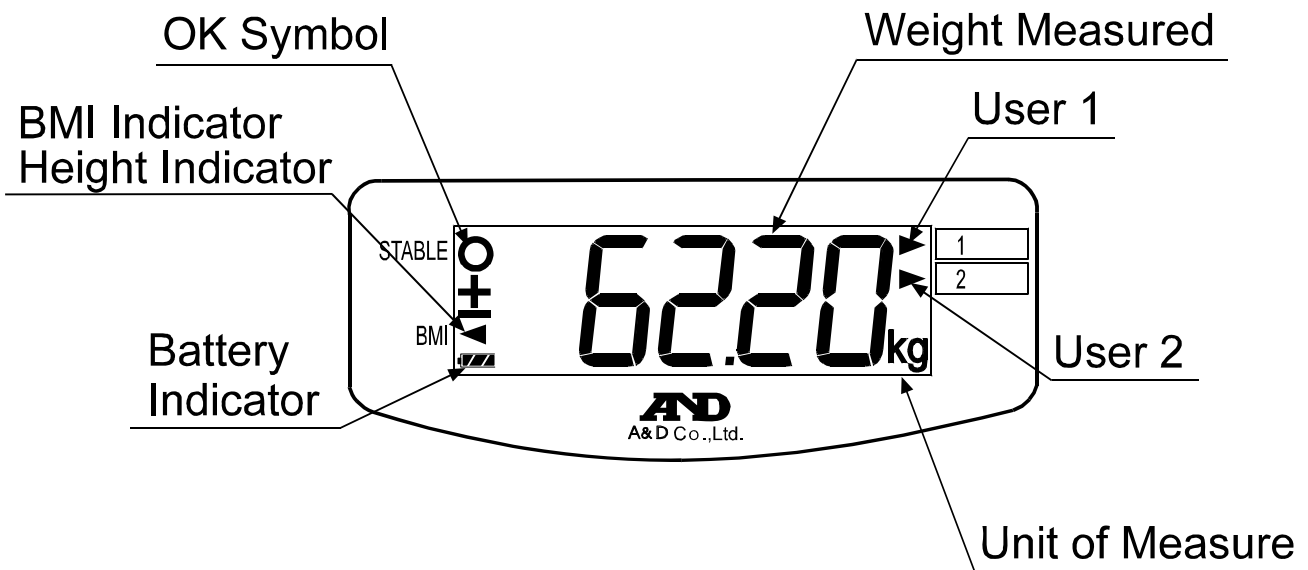

Symbol	Description	Operation
	This symbol appears when the measurement display is stable.	
 BMI	This symbol appears when the BMI score is displayed after weight measurement.	Refer to “Measuring Your Weight (With the preset height)” on page 7.
	This symbol appears when you are presetting your height.	Refer to “Presetting Your Height” on page 6.
 User 1	This symbol appears when user 1 is measuring, displaying memory data or presetting the height.	Refer to pages 6-8, 10 and 11.
 User 2	This symbol appears when user 2 is measuring, displaying memory data or presetting the height.	
	The battery capacity is sufficient.	Use the scale as is.
	The battery capacity is a little low.	
	The battery capacity is low.	Replace the batteries with new ones.
 Flashing	The battery capacity is very low.	Replace the batteries with new ones immediately.

Installing (or Replacing) Batteries

Caution

Insert each battery with its positive (+) and negative (-) terminals properly aligned with the corresponding symbols in the battery compartment. If you fail these battery directions, it may cause battery leakage.

Replace all four batteries with new ones, when the  symbol appears flashing.

When the batteries are completely depleted, nothing is displayed even if the switch is pressed.

Do not mix used and new batteries. It may cause damage to the battery or scale, if used.

The battery life is dependant upon the environmental temperature, battery type and usage.

Remove the batteries from the battery compartment, when the scale is not to be used for a long time. They may leak and damage your scale.

The battery life of the accessory batteries may be shorter than new ones.

Steps for Installing (or Replacing) Batteries

- 1 Remove the battery compartment cover on the underside of the scale by gently pushing the hook in the direction indicated by the arrow and lifting the cover backward.
- 2 Place four new batteries with the positive (+) and negative (-) terminals properly aligned with the corresponding symbols in the battery compartment.
- 3 Replace the cover by sliding it into the compartment and gently pressing into place.

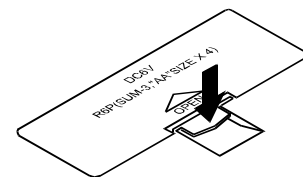
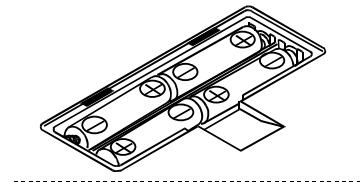
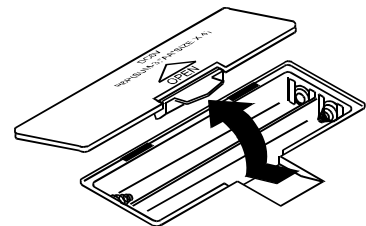

Maintaining the Scale

Clean the scale with a dry, soft cloth or a cloth moistened with water and a mild detergent. Never use alcohol, benzene, thinner or other harsh chemicals to clean the scale.

Remove the batteries, if the scale is not going to be used for a long time.

Measuring Your Weight on a Carpet

Please use the accessory add-on feet if you wish to use the Precision Health Scale on a carpet.

Steps for Installing the Add-on Feet

- 1 Each add-on foot has two pins. Match those pins to the holes on the scale leg and insert firmly.
- 2 Place add-on feet on all four legs.

Note

Please be careful not to fall when using the add-on feet.
We recommend using this scale on a solid and level surface.

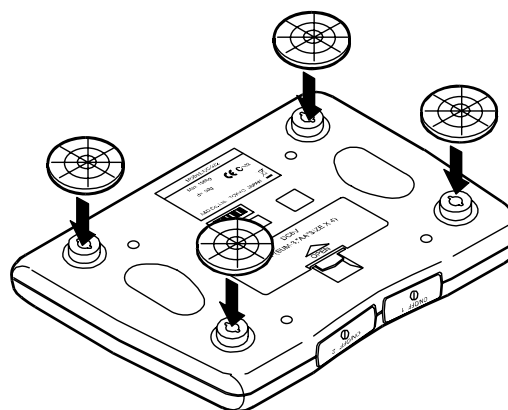
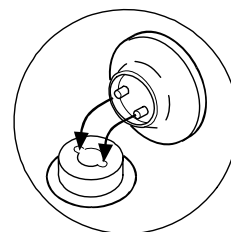

Before Measuring Your Weight

If you preset your height, the scale can calculate your Body Mass Index or BMI. Refer to “Presetting Your Height” on page 6.

What is BMI:

Body Mass Index or BMI (kg/m²), based on an individual’s height and weight, is a helpful indicator of underweight, overweight or obesity, in adults.

According to the WHO (World Health Organization) classification, the BMI scores are as listed to the right.

Underweight	Below 18.5
Normal	20 to 25
Overweight	25.0 to 29.9
Obese	30.0 and above
Very obese	Above 40

$$\text{BMI} = \frac{\text{Weight (kg)}}{\text{Height (m)} \times \text{Height (m)}}$$

The scale can save weight data for two persons, 15 data for each, in memory and display them later.

Refer to “Displaying Data Saved in Memory” on page 10.

Presetting Your Height

The scale can save a height between 30 cm and 220 cm in increments of 0.1 cm. The procedure below is an example of how to preset the height of user 1 to 179.1 cm.

- 1 With the scale turned off, press and hold the ON/OFF 1 switch.**

To preset the height of the user 2, press and hold the ON/OFF 2 switch.

- 2 Release the switch when - appears. Then, press the ON/OFF 1 switch again.**

- 3 The height currently set appears.**

When the height has not been preset (factory setting), OFF appears. Under this condition, the BMI calculation is not available.

- 4 Set your height.**

Press the ON/OFF 1 switch to decrease the number, the ON/OFF 2 switch to increase the number.

Press and hold the switch to increase or decrease the number continuously. The setting range is 30.0 cm to 220.0 cm. When the number reaches 220.0, OFF appears and the number returns to 30.0.

- 5 After five seconds, the height is saved in memory. End appears and the scale turns off automatically.**

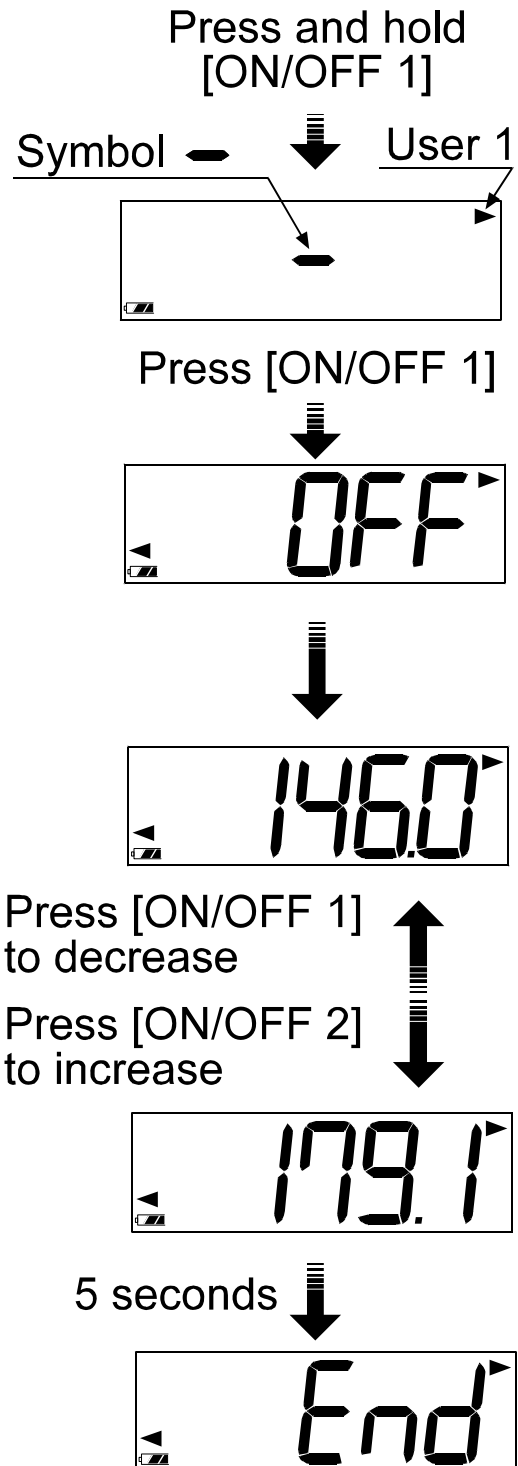

Measuring Your Weight (With the preset height)

Up to 15 weight data can be saved in memory, each for user 1 and for user 2. Additional measurements are saved by deleting the oldest data in memory. After measurement, the BMI score is displayed.

The procedure below is an example of how to measure the weight of user 1 with the preset height of 179.1 cm.

- 1 Press the ON/OFF 1 switch. The height currently set appears flashing.** To measure the weight of user 2, press the ON/OFF 2 switch.
- 2 Wait until the OK symbol appears.** Wait until the display 0.00 kg and the OK symbol appear. Step on the scale gently.
- 3 Stand still during measurement.** When the OK symbol disappears, the measurement sequence has initiated. Stand still during the measurement.
- 4 Your weight is displayed after the OK symbol appears.**
- 5 Step off the scale.**
- 6 The BMI score and the weight are displayed alternately. At this time, the weight is saved in memory.** After displaying the BMI score three times and the weight two times, the scale turns off automatically.

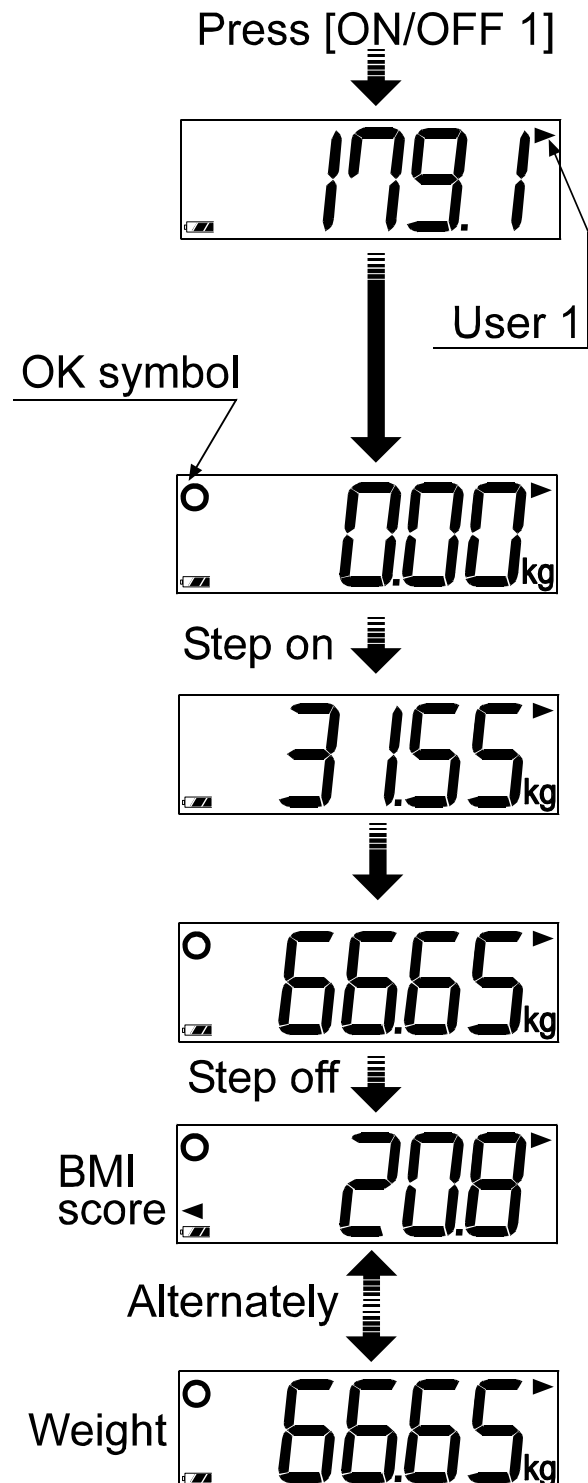

Measuring Your Weight (With no preset height)

Up to 15 weight data can be saved in memory, each for user 1 and for user 2. Additional measurements are saved by deleting the oldest data in memory.

The procedure below is an example of how to measure the weight of user 1, of whose height has not been preset.

- 1 **Press the ON/OFF 1 switch. 88888 appears flashing.**

To measure the weight of user 2, press the ON/OFF 2 switch.

- 2 **Wait until the OK symbol appears.**
Wait until the display 0.00 kg and the OK symbol appear. Step on the scale gently.

- 3 **Stand still during measurement.**
When the OK symbol disappears, the measurement sequence has initiated. Stand still during the measurement.

- 4 **Your weight is displayed after the OK symbol appears.**

- 5 **Step off the scale.**
For five seconds, the weight is displayed. At this time, the current measurement is saved. After five seconds, the scale turns off automatically.

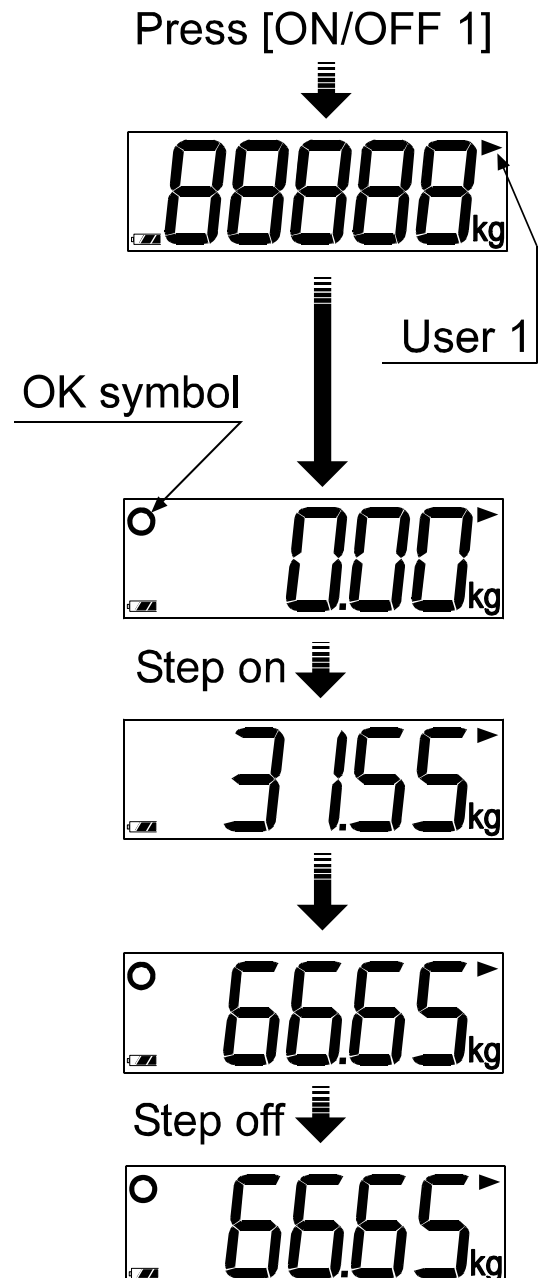

Measuring Your Weight (Guest mode)

The guest mode is a procedure to measure a weight without saving the weight data.

- 1 **Press the ON/OFF 1 and ON/OFF 2 switches at the same time. 88888 appears flashing.**

Press [ON/OFF 1]
and [ON/OFF 2]

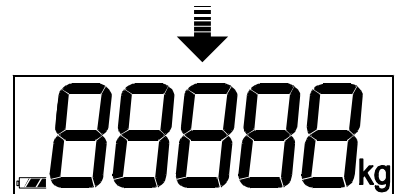

- 2 **Wait until the OK symbol appears.**
Wait until the display 0.00 kg and the OK symbol appear. Step on the scale gently.

OK symbol



- 3 **Stand still during measurement.**
When the OK symbol disappears, the measurement sequence has initiated. Stand still during the measurement.

Step on ↓

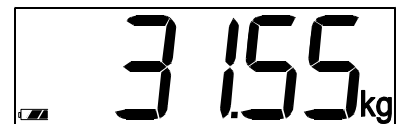

- 4 **Your weight is displayed after the OK symbol appears.**



- 5 **Step off the scale.**
For five seconds, the weight is displayed, and then the scale turns off automatically.

Step off ↓



Displaying Data Saved in Memory

The procedure below is an example of how to display the weight data of user 1 that was saved in memory.

- 1 **With the scale turned off, press and hold the ON/OFF 1 switch.**

To display the weight data of user 2, press and hold the ON/OFF 2 switch.

- 2 **Release the switch when - appears. Then, press the ON/OFF 2 switch within five seconds.**

If the ON/OFF 2 switch is not pressed within five seconds, the scale turns off automatically.

- 3 **The data number and weight data are displayed.**

Weight data is displayed in order from the most recent to the oldest.

- 4 **After the oldest data is displayed, End appears and the scale turns off automatically.**

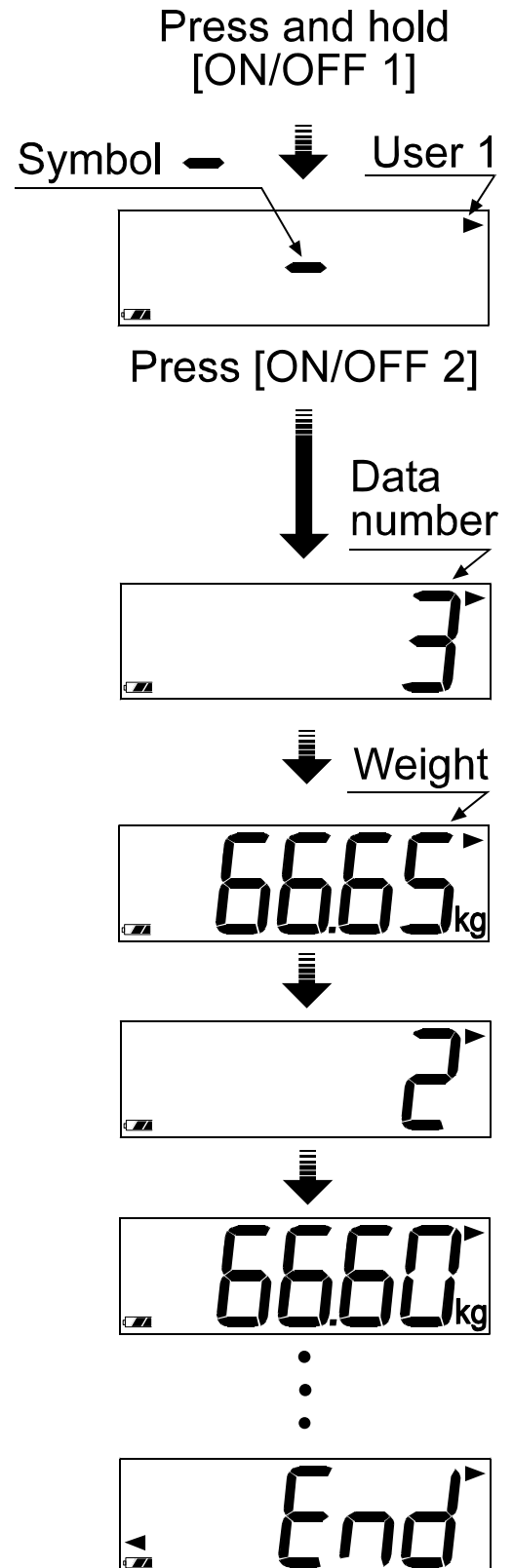

Deleting Data Saved in Memory

The procedure below is an example of how to delete the weight data of user 1 that was saved in memory.

- 1 **With the scale turned off, press and hold the ON/OFF 1 switch.**

To delete the weight data of user 2, press and hold the ON/OFF 2 switch.

- 2 **Release the switch when - appears. Then, press the ON/OFF 2 switch within five seconds.**

If the ON/OFF 2 switch is not pressed within five seconds, the scale turns off automatically.

- 3 **After displaying the number of data currently saved in memory for one second, the weight data is displayed.**

At this time, press and hold the ON/OFF 1 and ON/OFF 2 switches at the same time.

- 4 **Up to five dashes - appear from the right side of the display.**

If the switches are released before the display - - - - appears, the scale turns off automatically and does not delete the weight data.

- 5 **End appears and the scale deletes the weight data in memory.**

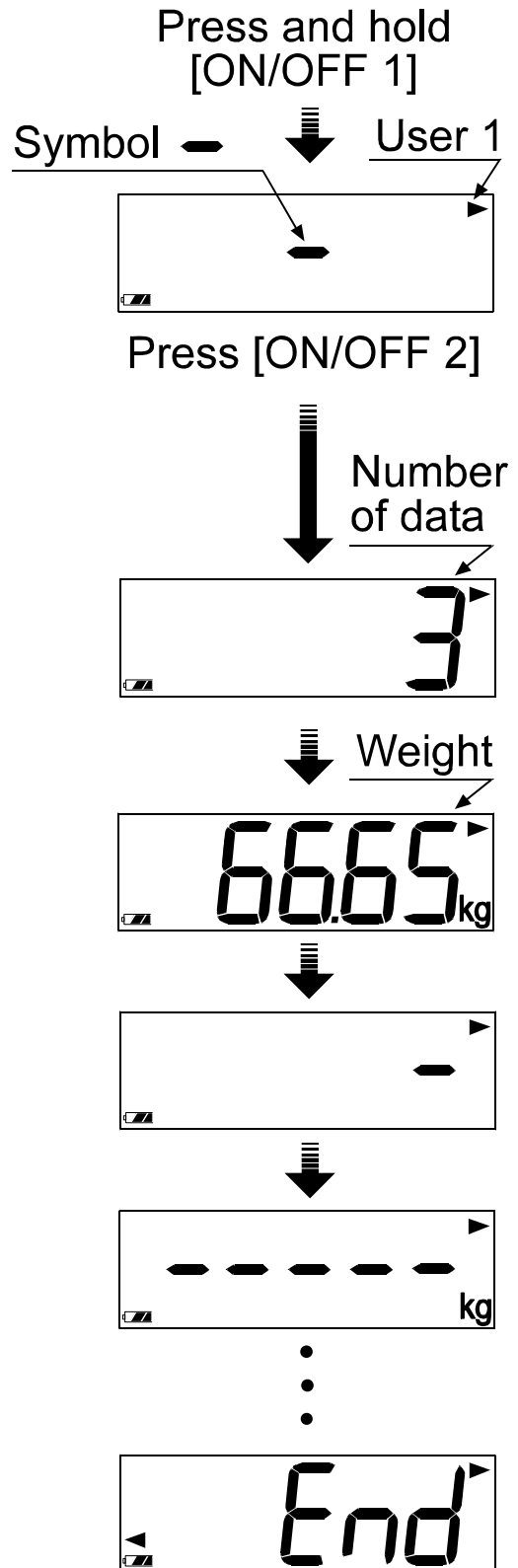

Specifications

Measuring method	Electric resistance
Digital display	Liquid crystal display, 18 mm character height
Maximum capacity (MAX)	150 kg
Minimum display (d)	0.05 kg
Power source	Four type AA batteries (R6P, 1.5 volt x 4)
Battery life	Approximately 2000 measurements
Dimensions	210 (D) x 295 (W) x 40 (H) mm
Weight	Approx. 1.7 kg, including the batteries
Accessories	Instruction manual, add-on feet (4), batteries (4)

Specifications are subject to change without prior notice and any obligation on the part of the manufacturer.

Before Requesting Service

Symptoms	Corrective action
Nothing is displayed by pressing the ON/OFF switch.	Check the battery installation. Replace all four batteries with new ones.
The display remains flashing or is fixed to the display - - - - . E-0 appears. H or L remains displayed.	Is anything touching the scale? Is there anything under the scale? Remove and reinstall the batteries.
The difference between an estimated weight and a measured weight is bigger.	Place the scale on a solid and level surface. When the scale is placed on a carpet, use the add-on feet. Is there anything under the scale?

How to Dispose of the Scale

Follow the local regulations when disposing of the scale.

A&D Co.,Ltd.

3-23-14 Higashi-Ikebukuro, Toshima-ku, Tokyo, 170-0013 JAPAN
Telephone: [81] (3) 5391-6132 Fax: [81] (3) 5391-6148

A&D INSTRUMENTS LTD.

<Authorized Representative Established in the European Community>

Unit 24/26 Blacklands Way, Abingdon Business Park, Abingdon, Oxon OX14 1DY United Kingdom
Telephone: [44](1235) 550420 Fax: [44] (1235) 550485

A&D MERCURY PTY. LTD.

32 Dew Street, Thebarton, South Australia 5031 AUSTRALIA
Telephone: [61] (8) 8301-8100 Fax: [61] (8) 8352-7409